



ବନଶକ୍ତ ଅଧିକାରୀ ତଥା ବନ୍ୟପ୍ରାଣୀ ତତ୍ତ୍ୱାବଧାରକଙ୍କ କାର୍ଯ୍ୟାଳୟ, ରାଉରକେଲା

**OFFICE OF THE DIVISIONAL FOREST OFFICER CUM WILDLIFE WARDEN
ROURKELA FOREST DIVISION, ROURKELA, SUNDARGARH, ODISHA**
Phone No. 0661-2664637, Fax No. 0661-2664638, e mail- dforourkela.od@gov.in

Memo No... 5743 Dt... 09/07/2022

To

The Deputy Director,
Information & Public Relation Department (Advertisement),
& Deputy Secretary to Government of Odisha,
Information & Public Relation Department,
Bhubaneswar.

Sub: Publication of Advertisement for Short Tender Notice for supply and installation of 29500 Nos of Iron Gabion in respect of Rourkela Forest Division under MGNREGS 2022-23.

Sir,

Enclosed, please find herewith the copy of Advertisement for Short Tender Notice for supply and installation of 29500 Nos of Iron Gabion in respect of Rourkela Forest Division under MGNREGS 2022-23 both in Hard & Soft Copy. It is requested to kindly make necessary arrangement for publication of the same at least in three leading Odia Daily News Paper as early as possible.

The Concerned Advertisement Manager may kindly be instructed to send complimentary copies of the same newspapers containing the Advertisement to the undersigned immediately after its publication.

An early action in this matter is requested.

Encl:- As above.

Yours faithfully,

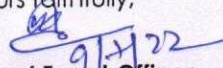
9/7/22
Divisional Forest Officer,
Rourkela Forest Division

Memo No... 5744 Dt... 09/07/2022

Copy along with its enclosure forwarded to the Add. Chief Conservator of Forests (IT & GIS), O/o the Principal Chief Conservator of Forests & HoFF, Odisha, Bhubaneswar for favour of kind information and necessary action. He is requested to upload the above short Tender Notice in the website of Pr. C.C.F, Odisha, as early as possible.

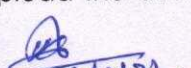
9/7/22
Divisional Forest Officer,
Rourkela Forest Division

Memo No... 5745 Dt... 09/07/2022

Copy forwarded to the Regional Chief Conservator of Forests, Rourkela Circle, Rourkela for favour of kind information and necessary action.

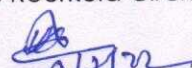
9/7/22
Divisional Forest Officer,
Rourkela Forest Division.

Memo No... 5746 Dt... 09/07/2022

Copy along with its enclosure forwarded to the District Informatics Officer, Sundargarh, NIC Unit, Sundargarh for favour of kind information and necessary action. He is requested to upload Short Tender Notice in District Portal Website as early as possible.

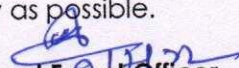
9/7/22
Divisional Forest Officer,
Rourkela Forest Division

Memo No.....5747 Dt.....09/07/2022

Copy forwarded to Divisional Forest Officer, (T&NT), Odisha for information and necessary action. It is requested to display the Short Tender Notice in their Office Notice Board.

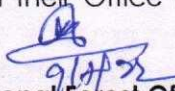
9/7/22
Divisional Forest Officer,
Rourkela Forest Division

Memo No.....5748 Dt.....09/07/2022

Copy along with its enclosure submitted to the Collector & District Magistrate, for favour of kind information and necessary action. It is requested to display the Short Tender Notice in their Office Notice Board.

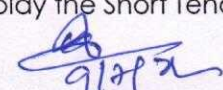
9/7/22
Divisional Forest Officer,
Rourkela Forest Division

Memo No.....5749 Dt.....09/07/2022

Copy along with its enclosure forwarded to all District level officer of the District for information and necessary action.

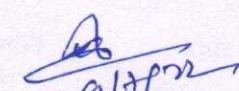
9/7/22
Divisional Forest Officer,
Rourkela Forest Division

Memo No.....5750 Dt.....09/07/2022

Copy along with its enclosure forwarded to all ACFs and all Range Officer of Rourkela Forest Division for information and necessary action. They are instructed to the above said "Short Tender Notice" in their Office Notice Board.

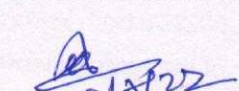
9/7/22
Divisional Forest Officer,
Rourkela Forest Division



ବନଖଣ୍ଡ ଅଧିକାରୀ ତଥା ବନ୍ୟପ୍ରାଣୀ ତତ୍ତ୍ୱାବଧାରକଙ୍କ କାର୍ଯ୍ୟାଳୟ, ରାଉରକେଲା
OFFICE OF THE DIVISIONAL FOREST OFFICER CUM WILDLIFE WARDEN
ROURKELA FOREST DIVISION, ROURKELA, SUNDARGARH, ODISHA
Phone No. 0661-2664637, Fax No. 0661-2664638, e mail- dforourkela.od@gov.in

Notice No. 310 Dated:09.07.2022

TENDER CALL NOTICE FOR "SUPPLY & INSTALLATION OF 29500 NOS. OF IRON GABION"

Sealed tenders are invited under Two-Bid system from reputed Manufacturer/ Suppliers, Dealers and Individuals for "SUPPLY & INSTALLATION OF 29500 NOS. OF IRON GABION" (7 FT height, Coloring, GI wire for binding, Fixing 03 nos. of leg of Iron Gabion by cement concrete including transportation.) to Rourkela Forest Division on terms and conditions mentioned in the standard bidding documents so as to reach in the O/o the DFO, Rourkela on or before 19.07.2022 up to 01:00 P.M through Registered/ Speed Post/ Courier Service and can also be dropped in Tender Box placed in Office of the Divisional Forest Officer, Rourkela Forest Division. The tenders will be opened on dt. 19.07.2022 at 04:00 PM in the O/o the Divisional Forest Officer, Rourkela. The standard bidding documents and terms and conditions can be downloaded from www.sundargarh.nic.in/www.odishaforest.in and also can be obtained from Office of the Divisional Forest Officer, Rourkela Division, Panposh from 11.07.2022 to 19.07.2022 up to 01:00 PM during office hours.

Tender inviting authority reserves the right of accepting or rejecting one or more tender offer(s) or cancelling the tender without assigning any reason thereof.

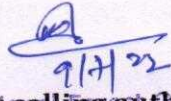
(Tender calling authority)
Divisional Forest Officer,
Rourkela Division

TENDER DOCUMENT
FOR SUPPLY OF 29500 NOS. OF IRON GABION
TO ROURKELA FOREST DIVISION, ROURKELA,
DIST-SUNDARGARH, ODISHA FOR THE YEAR 2022

It has been decided to procure and installation of 29500 nos. of Iron Gabion by inviting sealed tenders. The Dealer/Manufacturer/ Individuals or Persons expressing interest shall procure the tender application Form from the O/o the Divisional Forest Officer, Rourkela Forest Division, Rourkela on any working day from **10:00 AM to 01:00 PM** from **11.07.2022 to 19.07.2022**. The Cost of the Tender paper of Rs.7080/- (**Rs. 6,000/- + 18% GST**) only shall be deposited in shape of Demand Draft drawn in favour of the Divisional Forest Officer, Rourkela Forest Division payable at any nationalized/public bank of Rourkela Branch while submitting the tender.

The tenderer has to furnish all required documents & rate of the material, Taxes separately in the application form. The tenderer has to submit the technical bid and financial bid in two separate closed covers.

Eligibility: -

1. The invitation to participate in the Tender Document is open to Dealer/Manufacturer/Individual for Iron Gabion.
2. The Tenderer must not have been banned or black listed by any Government organization.
3. There must not be any adverse action pending against the Tenderer.

SALE OF TENDER DOCUMENT—11.07.2022 to 19.07.2022 up to 01:00 PM.

LAST DATE FOR SUBMISSION OF SEALED TENDER DOCUMENT- 19.07.2022 up to 05:00 PM.

OPENING OF TECHNICAL BID-19.07.2022 BY 04:00 PM.

OPENING OF FINANCIAL BID- AFTER APPROVAL OF TECHNICAL BID BY THE TENDER SELECTION COMMITTEE.

Divisional Forest Officer
Rourkela Forest Division

Terms & Conditions:-

1. The Tenderer shall supply & install Iron Gabion 7' Height, Coloring, GI Wire for binding, fixing of 03 nos. legs of Iron Gabion by cement concrete including transportation of the following specifications of materials.
 - a) MS Iron Flat of size : 20 mm X 3 mm for circular support.
 - b) MS Iron Flat of size : 20 mm X 5 mm for vertical support.
 - c) MS Name plate of size : 300 mm X 150 mm.
 - d) Primer with enamel paint on steel work.
 - e) For concrete block 20 mm size H.G.C.B metal, sand and cement.
 - f) The design of Iron Gabion & its measurement and specifications copy is enclosed as **Annexure-A**.
2. The Tenderer has to attach EMD @1% of the total Financial Bid Amount quoted by them in shape of Demand Draft purchased from any Nationalized/Public sector Bank in favour of Divisional Forest Officer, Rourkela Forest Division payable at any nationalized bank of Rourkela Branch along with the tender; otherwise, their bid shall not be qualified for the tender. The EMD shall be refunded to unsuccessful bidders.
3. The successful tenderer shall furnish a security deposit @3% of the total bid amount duly pledged in favour of the Divisional Forest Officer, Rourkela Forest Division in shape of Demand draft only drawn from any nationalized bank payable at Rourkela. This Security deposit of the successful tenderer shall be retained at Rourkela Forest Division & shall be returned after completion of the delivery of the materials. If the tenderer fails to supply and installation of the required quantity of the Iron Gabion in time as per agreement, then the security deposit shall be forfeited to Govt.
4. The Technical bid only shall be opened on **19.07.2022 at 04:00 PM**. The Tender Selection Committee may inspect the Iron Gabion production site mentioned by the bidder for on the site evaluation and sample collection. The date of opening of Financial Bid shall be communicated through the Notice Board of Division Office.
5. The Tenderer shall execute an agreement with the Divisional Forest Officer, Rourkela Forest Division in line with the terms and conditions laid out in the tender document.
6. The Tenderer shall supply & install the Iron Gabion at the approved sites as enclosed as **Annexure-B**.
7. The material should be delivered on the site after sampling at respective Range Offices and proper weighing **in presence of the Forest Range Officer In-charge of the Range & taking counter signature on Challan Copy**.
8. A Sample of the Iron Gabion shall be sent to any authorized laboratory for analysis. The Laboratory analysis report should match the specification furnished by the Tenderer in the original tender application form and the sample collected by the Tender Selection Committee. Failing to comply the Laboratory approval, the tenderer shall be responsible for non-payment of material cost & the material shall not be accepted.
9. The cost of materials furnished in the bid document shall be inclusive of transportation charges, fixing and all Taxes admissible.



Divisional Forest Officer
Rourkela Forest Division

10. All payments to the Tenderer including EMD and Security Deposit shall be adjusted after completion of delivery & installation of approved quality Iron Gabion from **available MGNREGS material component subject to registration of vendor in proper time.**
11. All documents and Original tender paper with Form No. A and B should be signed by the Tenderer.
12. Tenderers supplying Iron Gabion having better quality materials will be preferred over inferior ones without considering the L1.
13. DFO, Rourkela is at liberty to increase or decrease the quantity mentioned. Items mentioned may be dropped also keeping in view the requirement of stores/service components at the site/field at the time of placing the work order.

Place:

Date:

Signature of the Tenderer

Divisional Forest Officer
Forest Division

DOCUMENTS TO BE SUBMITTED ALONG WITH ORIGINAL TENDER PAPER

1. Demand Draft in Original for (Rs. 6,000/- + 18% GST) = Rs.7,080/- (Rupees Seven Thousand Eighty) only drawn in Favour of "**Divisional Forest Officer, Rourkela Forest Division**" as per bank details provided towards the cost of Tender papers and Processing for each individual work.
2. Demand Draft in Original being the 1% EMD of the total financial bid amount.
3. Copy of Valid GST Registration Certificate.
4. Copy of valid PAN Card.
5. Copy of GST Clearance Certificate for the year 2020-21 & 2021-22.
6. Income Tax Clearance Certificate for the year 2020-21 & 2021-22.
7. Copy of Annual Turnover (Minimum 1 crore) duly Audited by Reputed Chattered Accountant Firm for last Financial Year i.e.2021-22.
8. Copy of Work order of similar nature of work completed earlier, if any.
9. Certificate for Authorized Dealer/ Manufacturer/ Supplier/ Individual.
10. The tenderer shall submit a sample while dropping of tender paper in the office of the DFO, Rourkela in person.

Place:
Date:

Signature of the Tenderer

Divisional Forest Officer
Rourkela Forest Division

FORM-A
TECHNICAL BID FOR SUPPLY AND INSTALLATION OF IRON GABION
DURING 2022-23 TO ROURKELA FOREST DIVISION, ROURKELA

1. Name of the Bidder/ Organization
2. Detailed Address of Bidder
3. E-mail ID: _____
4. Telephone/Mobile No.: _____
5. PAN No.: _____
6. GST No.: _____
7. Period of clearance of GST: _____
8. Detail address of the Iron Gabion production site/Unit.
9. Annual turnover of the tendering Agency/Organization.
10. Present Capacity of the bidder to supply & install Iron Gabion with (in MT).
- 11.

S1. No	Name of the site of stock of Iron Gabion	Quantity of Iron Gabion available (in Nos.)	Capacity of the Tenderer to supply & install Iron Gabion within 15 days time period (in Nos.)

12. The Specification details of the Iron Gabion be submitted by the Tenderer.

Certified that the information provided above is true and the organization has never been debarred or black listed by any Government Organization.

Date:
Place:

Name & Signature of the Tenderer

Divisional Forest Officer
Rourkela Forest Division

FORM-B
FINANCIAL BID FOR SUPPLY & INSTALLATION OF IRON GABION
DURING 2022-23
TO ROURKELA FOREST DIVISION, ROURKELA

1. Name of the Bidder/Organization
2. Detailed Address of Bidder
3. E-mail ID: _____
4. Telephone/Mobile No.: _____
5. Unit Cost for supply & installation (inclusive of transportation cost & all taxes) of Iron Gabion of size 7' Height, circular in shape with diameter of 4' (7' X 4') (in Rs): _____
6. Total Financial bid amount for 29,500 nos. Iron Gabion.
7. Amount of EMD in shape of demand draft enclosed: _____

Certified that the information provided above is true to the best of my knowledge.

Date:
Place:

Name & Signature of the Tenderer

Division Forest Officer
Rourkela Forest Division

IRON GABION DESIGN

Annexure - A

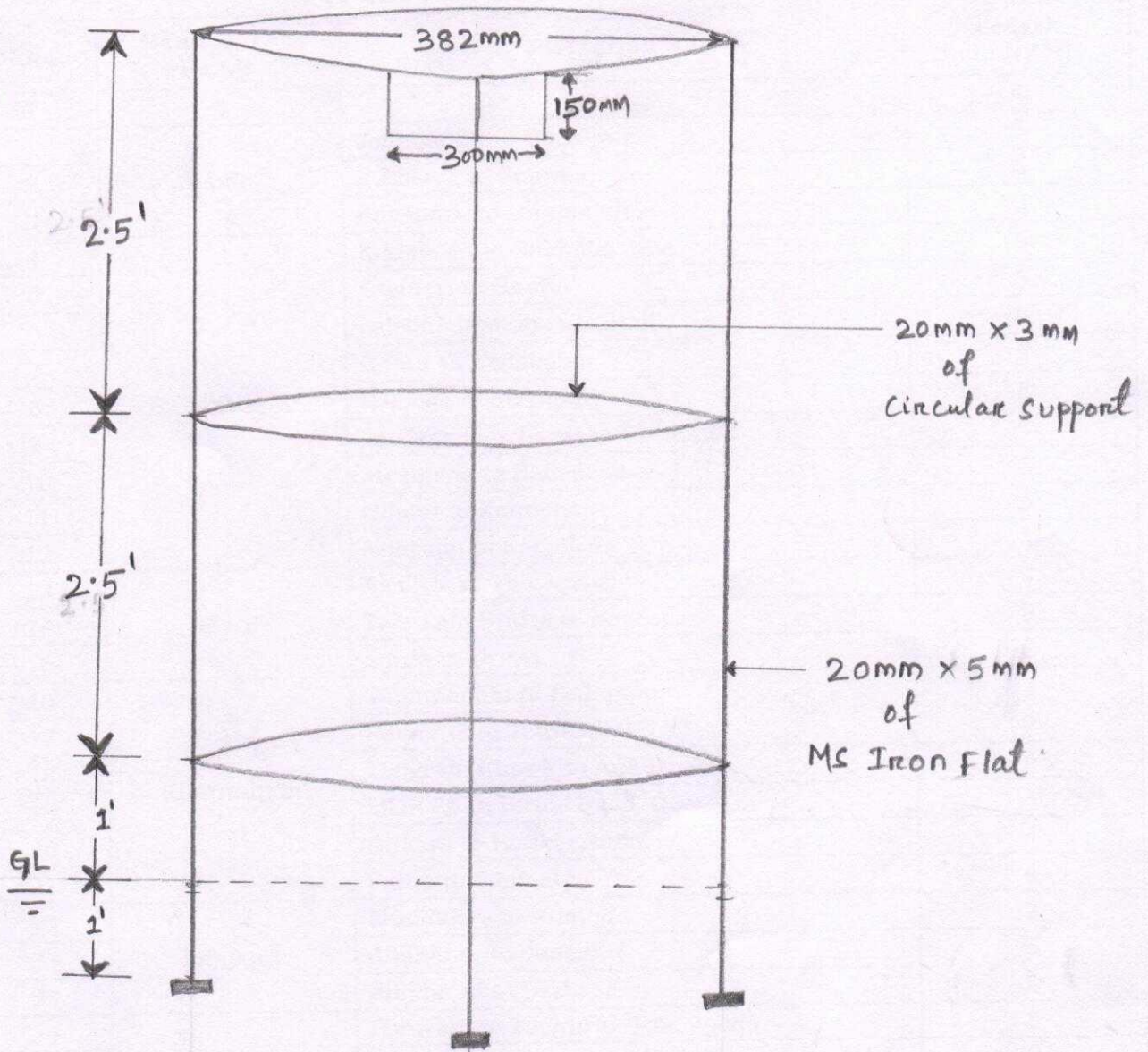

Divisional Forest Officer
Rourkela Forest Division

AVENUE PLANTATION			Annexure-B
Sl No.	Name of the Range	Plantation Site	Length (in RKM)
1	2	3	4
1	Banki	Jodabandh to Gopalpur	6
2		K.Bolang to Saprambeda	5
3		Kaleiposh to Dhamnadhar	3
4	Biramitrapur	Kudabeda to Sukhabandha	5
5		Sagjuari to Gopur	5
6		Laleikhaman to Pahadtoli	5
7		Gopur to Kadobahal	5
8		Raiboga to Indrapur	5
9		Jaydega Panchayat to Chutiatoli	5
10		Menmena to Baliaposh	5
11		Olhani to Kantajhar	5
12		Nuagaon to Sanjojoda	5
13		Bisra	Ajeikela to Theteiposh
14	Teterkela Bridge to Bagdega		5
15	Sorda to Urmei		5
16	Kuarmunda	Jamunanaki to Padampur	3
17		Raiberna to Tetrabahal	3
18		Tangrani Chowk to Ankurpali	3
19		MDR 26 to Birual Road	3
20		Birkera to Hatibarikona	4
21		Patua to Sanmaren	4
22	Panposh	Mundajore to Nuatoli	2
23		Amjharan to Jangidiri	5
24		Amjharan to Barbeda	5
25	Rajgangpur	Bahiyam to Topkurlu Schoolpada	5
26		Bahiyam Chowk to RC Chowk	2
27		Khilaripada to Chinimohul	5
		Total Avenue Plantation 118 RKM	118

 9/11/22
 Divisional Forest Officer
 Rourkela Forest Division